

Delivering leading edge, innovative power solutions for more than **30** years....

Model:GT-83082-3612-W2E

September 21, 2020

GT-83082-3612-W2E

Information

Model Number	GT-83082-3612-W2E
Description	GT-83082-3612-W2E, ITE Power Supply, Wall Plug-in, Regulated Switchmode AC-DC; Current Limited Power Supply AC Adaptor, , Input Rating: 100-240V~, 50-60 Hz, European CEE 7/16 configuration:EN 50075 Europlug 2 PIN, Output Rating: 36 Watts, Power rating with convection cooling (W) , 12V in 0.1V increments, Approvals: CB 60950; Double Insulation; CE; RoHS; WEEE; SIQ; Ukraine; Level VI;

Model Picture



Agency Documents	http://www.globtek.info/certs/GT-83082-W2Z/
CE EC-Declaration	https://www.globtek.com/pdf/ec_declaration/a00a000000MiZX8EAN
RoHS/RoHS2 Declaration	https://www.globtek.com/pdf/rohs_cert/a00a000000MiZX8EAN
REACH Declaration	https://www.globtek.com/pdf/iso_certificates/REACH.pdf
Conflict Minerals Declaration	https://www.globtek.com/pdf/conflict-minerals.pdf

Delivering leading edge, innovative power solutions for more than **30** years....

Model:GT-83082-3612-W2E

September 21, 2020

MODEL PARAMETERS

Type	Wall Plug-in
Technology	Regulated Switchmode AC-DC; Current Limited Power Supply AC Adaptor
Category	ITE Power Supply
Input Voltage	100-240V~, 50-60 Hz
I/P Amps (A)	1.0A
Wattage (W)	36.0
Vout Range (V)	12
Efficiency Level	USA DOE Level VI / Eco-design Directive 2009/125/EC, (EU) 2019/1782
Ingress Protection	
Size (mm)	94(L)*34(W)*91.85 (H) mm maximum

Delivering leading edge, innovative power solutions for more than 30 years....

Model:GT-83082-3612-W2E

September 21, 2020

ENCLOSURE

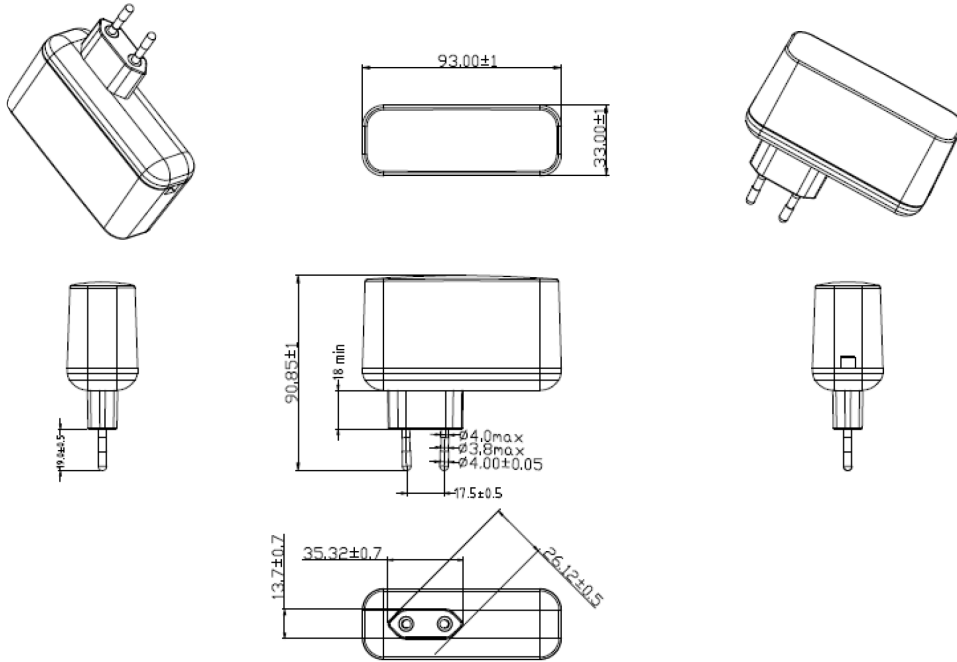

Delivering leading edge, innovative power solutions for more than **30** years....

Model:GT-83082-3612-W2E

September 21, 2020

RATING TABLE

Model Number	Voltage	Amps(A)	Watts(W)	RFQ
GT-83082-3612-W2E	12 V	3	36.00	RFQ
GT-83082-3012-W2E	12 V	2.5	30.00	RFQ

SPECIFICATIONS

01. Input Voltage: Specified 90-264 Vac, Nameplate rated: 100-240Vac
02. Input Frequency: Specified 47-63 Hz, Nameplate rated 50-60Hz
03. The adapter input/output are full range AC input and +12V DC with 36 watts maximum output.
04. NOMINAL AC INPUT VOLTAGE 1 A maximum, No damage shall be occurred and the input fuse shall not be blown up.
05. POWER CONSUMPTION: 115VAC/230VAC INPUT , power consumption less than 0.1W
- 06.200 mVp-p maximum Ripple and Noise:At 20 MHz, and output parallel with 0.1uF & 47uF capacitors to ground. Temperature at 25°C, and nominal input voltage (Optional 120 mVp-p maximum Ripple)
07. Turn-ON Delay: 3 Seconds maximum at nominal input voltage
08. Inrush Current: at full load, 25°C, cold start
09. RISE TIME: 100mS maximum at nominal input voltage
- 10.Efficiency: Compliant with Efficiency Level VI and CoC Tier 2 standards
11. No Load Standby Power: <0.075W @ 230Vac
12. Capacitance load ability(CR mode): 12V,Output set CR mode,and 4000uF capacitor @115Vac/60Hz and 230Vac/50Hz ; 0% and 100% load
13. OUTPUT REGULATION +/-5%

B) PROTECTION

01. Over-current protection
02. Over-voltage protection
03. Short-circuit protection:Short circuit protection is to be included in the construction of the adaptor. The adaptor is designed to withstand continuous current of a short circuit on the output. The adaptor will be short circuit tolerant for an indefinite period.

C) SAFETY

01. Dielectric Withstand Voltage: Primary To Secondary: 3000VAC 10mA 1minute or 4242VDC 10mA 1minute
02. 0.25mA maximum, at nominal AC input voltage and frequency
03. Touch Current: <0.25mA @ 240Vac input voltage

D) EMC

01. Emissions, per EN 55032, EN 61000-6-3, EN 61000-6-4
 - Conducted Emissions: Class B, FCC Part 15, Class B
 - Radiated Emissions: Class B, FCC Part 15, Class B
02. Line Frequency Harmonics EN61000-3-2, Class A
03. Voltage Fluctuations/Flicker EN61000-3-3
04. Immunity, per EN 55024, EN 61000-6-1, EN 61000-6-2
 - Static Discharge Immunity EN61000-4-2, 4kV Contact Discharge, 8kV air discharge
 - Radiated RF Immunity EN61000-4-3, 3V/m 80-1000MHz, 80% 1KHz AM.
 - EFT/Burst Immunity EN61000-4-4, 1kV/100kHz.
 - Line Surge Immunity EN61000-4-5, 1kV differential, 2kV common-mode
 - Conducted RF Immunity EN61000-4-6, 3Vrms, 80% 1KHz AM
 - Power Frequency Magnetic Field Immunity EN61000-4-8, 1A/m
 - Voltage Dip Immunity EN61000-4-11, Criteria

Delivering leading edge, innovative power solutions for more than **30** years....

Model:GT-83082-3612-W2E

September 21, 2020

E) OTHER:

- 01. MTBF: 200,000 Hours @ 25°C ambient temperature
- 02. Operating Temperature: -5 °C TO 45 °C
- 03. Operating Humidity: 20 ~ 85 % RH. non-condensing
- 05. Storage Temperature: -20 °C TO +80 °C
- 06. Storage Humidity:5 ~ 95 % RH. non-condensing
- 07. Cooling: Cooling shall be with natural convection cooling
- 08. RoHS 2: Complies with EU 2011/65/EU China SJ/T 11364-2014

F) ENCLOSURE

- 01. Housing: High impact plastic, 94V0 polycarbonate, non-vented
- 02. Markings: Label and/or Pad Printed and/or Molded in the case

Delivering leading edge, innovative power solutions for more than 30 years....

Model:GT-83082-3612-W2E

September 21, 2020

DERATING CURVE



Delivering leading edge, innovative power solutions for more than 30 years....

Model:GT-83082-3612-W2E

September 21, 2020

INPUT CONFIGURATIONDescription European CEE 7/16 configuration:EN 50075 Europlug 2 PIN

The prongs of the Europlug are 19 mm long. They consist of a 9 mm long conductive tip of 4 mm diameter with a rounded ending, followed by a 10 mm long flexible insulated shaft of not more than 3.8 mm diameter. The two prongs are not exactly parallel and converge slightly; their centres are 19 mm apart at the tip and 18.6 mm apart at the base. The elasticity of the converging prongs provides sufficient contact force for the Europlug's current rating with a variety of socket-hole arrangements. The entire plug is 35.3 mm wide and 13.7 mm high, and must not exceed these dimensions within 18 mm behind its front plane (this allows for the recesses on many European socket types). The left and right side of the plug are formed by surfaces that are at 45° relative to the horizontal plan.

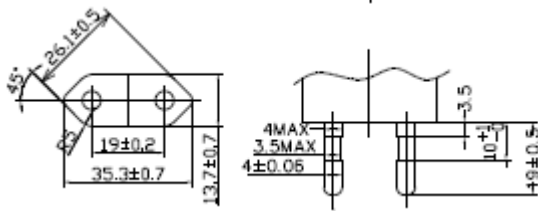
**PROPRIETARY INFORMATION**

PROPRIETARY OF GLOBTEK, INC. ANY REPRODUCTION, DISCLOSURE OR USE OF THIS DRAWING, IN WHOLE OR IN PART, IS HEREBY PROHIBITED EXCEPT AS SPECIFIED IN WRITING BY GLOBTEK, INC.

<http://en.globtek.com/datasheet/id/a00a000000MiZX8>

Delivering leading edge, innovative power solutions for more than 30 years....

Model:GT-83082-3612-W2E

September 21, 2020

OUTPUT CONFIGURATION

Common output connector options:

 L Type (Coaxial
5.5x2.5mm plug)

 C Type (Coaxial
5.5x2.1mm plug)

 K Type (Coaxial
3.5x1.3mm plug)

 LL Type (5.5x2.5mm
Locking 760k type)

 CL Type (5.5x2.1mm
Locking S761k type)

 ML2 Type (Molex
housing 43025-0200)

 YL3 Type
(KPPX-3P)

YL4 Type (KPPX-4P)

 EJ1/2/3/4/5 (EIAJ
RC-5320A type
connectors)

 MSB Type (Micro
USB)

 USBC Type (USB
Type C)

 Inquire for custom
design

 For a comprehensive list of options, [click here](#)







Contact GlobTek for your specific requirements or custom solutions.

Delivering leading edge, innovative power solutions for more than 30 years....

Model:GT-83082-3612-W2E

September 21, 2020

Approvals

Logo	Description
	Attention Mark / Refer to operating manual for operating and service instructions
No Logo	CB Certificate IEC 60950-1:2005 (2nd Edition), Am 1: 2009, CB report IEC 60950-1:2005 (2nd Edition), Am 1: 2009 and EN 60950-1:2006 + Am 1:2010 + Am 11:2009 + Am 12:2011
	CE Mark: tested to comply with EN55022:2006/A1:2007 Class B, EN610003-2, EN610003-3 including EN61000-4-2, EN61000-4-3, EN61000-4-4, EN61000-4-5, EN61000-4-6N EN61000-4-11; EMI: Complies with EN55011 CLASS B and FCC Part 15B - On label or Molded in case
	Indoor Use Only - Mark is on the label or Molded in the case
EFFICIENCY LEVEL 	Efficiency: complies to section 301 of Energy Independence and Security Act (EISA) complies with Energy Star tier 2 (North America), ECP tier 2 (China), MEPS tier 2 (Australia), Code of Conduct (Europe)
RoHS	Specifications of directive 2011/65/EU Annex VI (ROHS-2) with amendment 2015/863-EU (ROHS-3) http://www.ce-mark.com/Rohs%20final.pdf
 IEC/EN60950-1	SIQ Mark License EN60950-1
 10276	Ukraine UKRSePro (Document: www.globtek.com/html/iso_certificates/GT_Ukraine.pdf)
	WEEE: Complies with EU 2012/19/EU (http://ec.europa.eu/environment/waste/weee/index_en.htm) Mark is on the label or Molded in the case